

**MODELS:**

Voltage	Output	Number of poles	Cable gland	Luminous Flux	R <sub>a</sub>	Beam Angle	Length	Weight	Order Number
220 - 240 V AC	30 W	2 pole	M16	4,000 lm	> 80	110°/158°	1,200 mm	1,0 kg	<b>KLF28</b>
		3 pole	M20			110°/140°		1,2 kg	<b>KLF30/3P1200</b>
	45 W	2 pole	M16	6,000 lm		110°/158°	1,600 mm	1,4 kg	<b>KLF48</b>
		3 pole	M20			110°/140°		1,5 kg	<b>KLF45/3P</b>
	66 W	2 pole	M16	9,000 lm		110°/127°	1,600 mm	1,6 kg	<b>KLF66</b>
		3 pole	M20					1,6 kg	<b>KLF66/3P</b>

**SPECIAL FEATURES:**

- up to 133 lm/W or 136 lm/W
  - colour temperature: 4,000 K
  - life-time L90B10 (up to 50,000 hours)
  - protection class: IP66
  - housing made of polycarbonate
  - ambient temperature: -30°C bis +40°C
  - including mounting clips with easy-click fixation made from stainless steel
  - optional mounting clips with safety screws (Order No.: KLF/MKS)
  - 2 pole through-wiring with connection terminal up to 1,5 mm<sup>2</sup> or 3 pole through-wiring with connection terminal up to 2,5 mm<sup>2</sup>
  - suitable to be used in companies of the food and beverages sector that are certified according to IFS version 6 and/or BRC Global Standard Food Version 7
- high efficiency
  - similar to daylight
  - designated long-life cycle
  - dustproof and water-jet-proof
  - IK10, impact-resistant
  - also suited for use when temperatures greatly fluctuate in both indoor and outdoor areas
  - convenient installation
  - anti-vandalism
  - number of linking luminaires per circuit depending on model (permanently installed)
    - 30 W: up to 33 luminaires
    - 45 W: up to 24 luminaires
    - 66 W: up to 21 luminaires

- other models on request / subject to modification and errors -

**LIGHT EMISSION KLF28:**

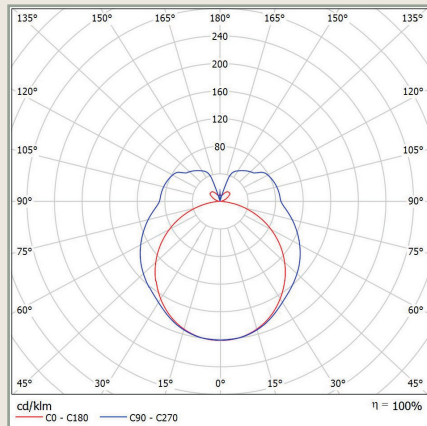

Horizontal: 110° / Vertical: 158°

**LIGHT EMISSION KLF48:**

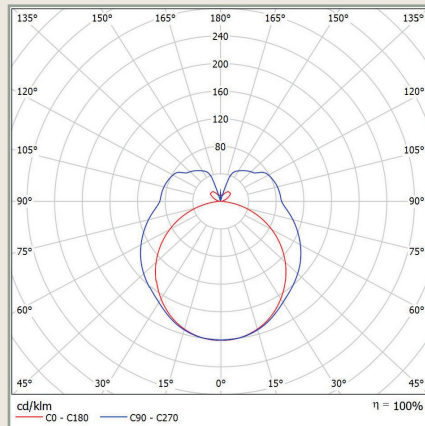

Horizontal: 110° / Vertical: 158°

**LIGHT EMISSION KLF66:**

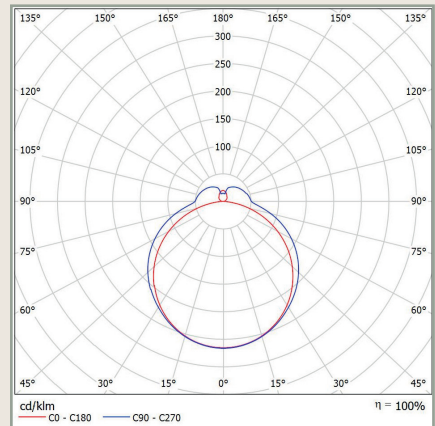

Horizontal: 110° / Vertical: 127°

**LIGHT EMISSION KLF30/3P:**

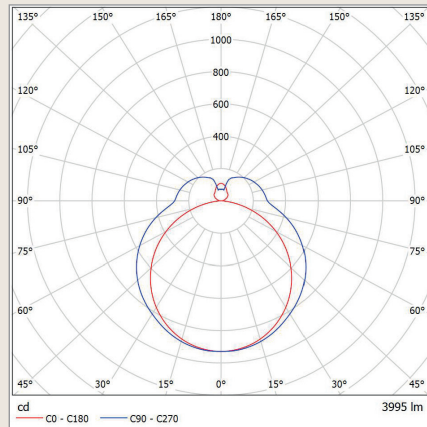

Horizontal: 110° / Vertical: 140°

**LIGHT EMISSION KLF45/3P:**

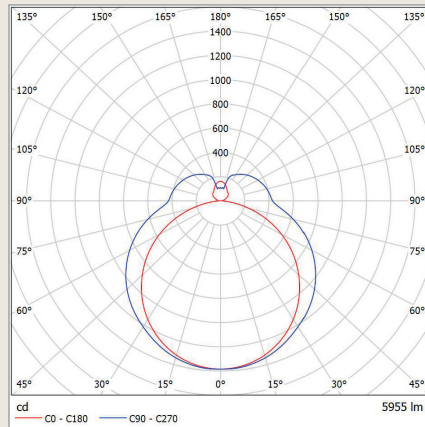

Horizontal: 110° / Vertical: 140°

**LIGHT EMISSION KLF66/3P:**

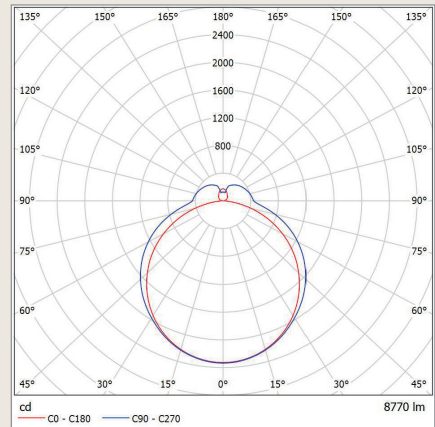

Horizontal: 110° / Vertical: 127°

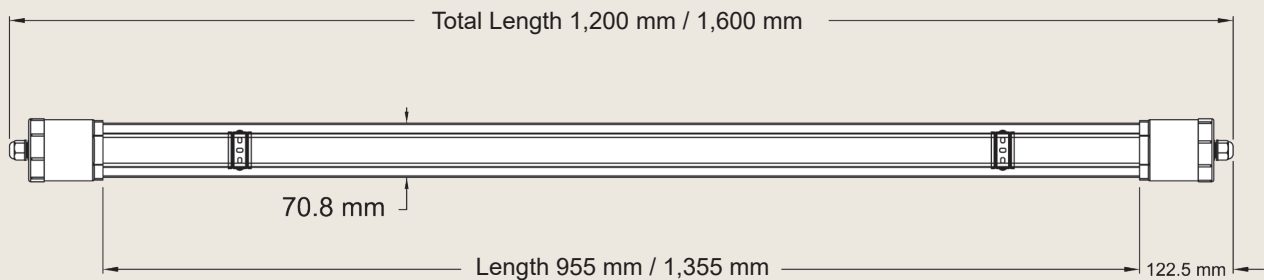

**MOUNTING OPTIONS:**

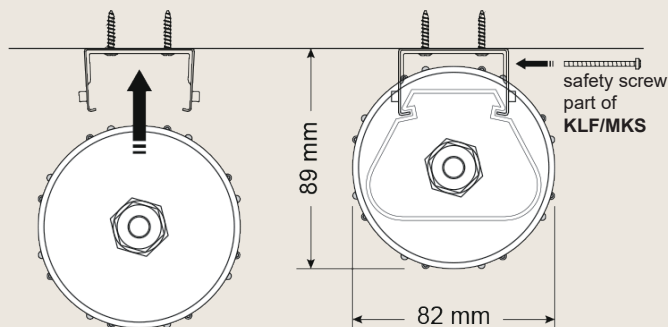

**ACCESSORIES:**

Order No.

2 pieces mounting clips with safety screw

**KLF/MKS**

2 pieces end-caps with cable gland M16 (cable diameter 5 - 10 mm)  
or  
cable gland M20 (cable diameter 6 - 12 mm)

**KLF/KAPSETM16**

**KLF/KAPSETM20**

- other models on request / subject to modification and errors -